

SAMUEL HEATH

Product Number: V7K15LKNP

Description: 3 Hole basin filler without pop-up waste, 198mm spout height

Standards

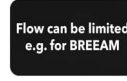

Flow rates

Litres/Min	0.1 Bar	0.5 Bar	1.0 Bar	2.0 Bar	3.0 Bar	4.0 Bar	5.0 Bar
		2.5	3.7	5.2	6.6	7.6	8.7

Flow rate data provided is indicative of each product and is given in open outlet conditions. Installation design, external connections and fittings not supplied may affect the data provided.

Finishes Available



Chrome Plate



Polished Nickel



Stainless Steel Finish



Stainless Steel with Matt Black



Urban Brass



City Bronze



Matt Black Chrome



Country Bronze



Urban Brass Matt Lacquered



Antique Brass Matt



Antique Brass Gloss



Amber Brass



Anthracite

Control Options Available



Specification Drawing

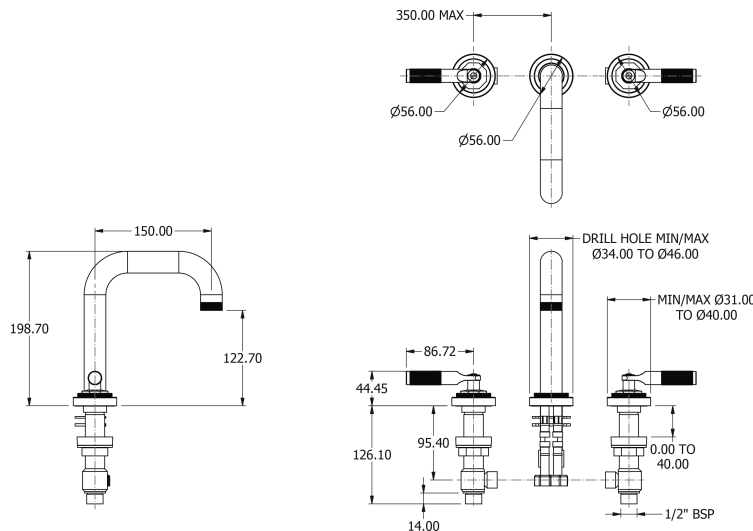

UK Customer Service

Leopold Street
Birmingham
B12 0UJ
Tel: +44 121 766 4200
Email: info@samuel-heath.com

US Customer Service

Federal I.D. No. 58-1504682
Email: usa@samuel-heath.com

Specification Enquiries

Design Centre Chelsea Harbour
1st Floor, North Dome, London
SW10 0XE
Tel: 020 7352 0249
Email: showroom@samuel-heath.com